

Superseded by 19EA-255

3/70

Hermetic Centrifugal Liquid Chillers

INTRODUCTION

All persons concerned with the start-up and operation of the 19EA machine should understand these instructions and all necessary job data before initial start-up. Instructions are in proper sequence for optimum machine performance.

Data and Equipment Required

- PRINTS:** Machine assembly, wiring, and piping
 Starter diagrams
 Special controls and related wiring (if any)
- INSTRUCTIONS:** 19EA Installation book
 19EA Operating and Maintenance book
 Starter Instructions
- MATERIALS:** Mechanics' tools, electronic or halide leak detector, clamp-on ammeter, volt-ohmmeter

INITIAL PREPARATIONS

Machine Tightness — The 19EA is shipped with the refrigerant charge in the utility vessel and a holding charge (10 psig) in the unishell. Several levels of leak testing may be required depending on condition of machine on arrival and at start-up. Determine machine condition and follow procedure indicated in Table 1.

For transferring refrigerant and evacuating vessels, follow the pumpout instructions on pages 3 and 4.

Table 1 — Selection of Leak Test Procedures

MACHINE CONDITION	PROCEDURE
1. Unishell holding charge and utility vessel refrigerant level unchanged.	4
2. Unishell holding charge decreased slightly.	3 and 4 on unishell
3. Utility vessel refrigerant level decreased slightly.	Leak test with halide or electronic leak detector.
4. Unishell holding charge completely gone. Opened valve or other open connection suspected.	1
5. Unishell holding charge completely gone. Vessel leak assumed.	2, 3, and 4 on unishell
6. Refrigerant charge in utility vessel completely gone. Opened valve or other open connection suspected.	1 - Use nitrogen with R-12 tracer in pressurizing for leak test procedures 2 and 3
7. Refrigerant charge in utility vessel completely gone. Vessel leak assumed.	2, 3, and 4 on utility vessel. Use nitrogen with R-12 tracer for pressurizing in 2 and 3

WARNING: Never charge liquid refrigerant into the unishell if vessel pressure is below 35 psig or with water pumps not operating. Cooler tube freeze-up and considerable damage may result.

PROCEDURE 1 — Standing Vacuum Test

1. Attach a mercury manometer (absolute pressure-type) to the refrigerant charging valve, (6) Fig. 1. A dial-type gage cannot indicate the small amount of leakage acceptable during a short period of time.
2. Pull a vacuum on the vessel (see evacuating procedures on page 3) equal to 25 in. Hg, ref 30-in. bar. (2.5 psia), using the pumpout system pump.
3. Valve off pump to hold vacuum, and record manometer reading.
4. If the leakage rate is less than 0.05 in. Hg/24 hours, perform procedure 3, all steps under Machine Dehydration and procedure 4.
5. If the leakage rate exceeds 0.05 in. Hg/24 hours, perform procedures 2, 3, all steps under Machine Dehydration, and procedure 4 in the order indicated.
6. Remove mercury manometer from refrigerant charging valve.

PROCEDURE 2 — Follow steps 1 thru 4 of Return Refrigerant to Normal Operating Conditions, page 3. Raise vessel pressure slowly to 5 psig by cracking open valve 4. Perform leak test with halide or electronic detector and repair any leaks.

PROCEDURE 3 — Following steps 1 thru 5 of Return Refrigerant to Normal Operating Conditions, page 3, raise vessel pressure to 35 psig. Perform leak test with halide or electronic detector and repair any leaks.

PROCEDURE 4 — Equalize pressure between utility vessel and unishell following steps 1 thru 5 of Return Refrigerant to Normal Operating Conditions, page 3. Vessel pressure will be approximately 70 psig. Perform leak test with halide or electronic detector and repair any leaks.

If refrigerant charge was lost and nitrogen has been used for pressurizing in procedures 2 and 3, evacuate vessel and then charge 400 lb of R-12 for procedure 4. If vessels are then leak tight, continue charging refrigerant to the level indicated in Charging Quantity Table below.

Table 2 — Charging Quantity

MACHINE SIZE	WEIGHT (lb R-12)
19EA 400, 430, 465	2000
19EA 500, 550	2200
19EA 590, 630	2400

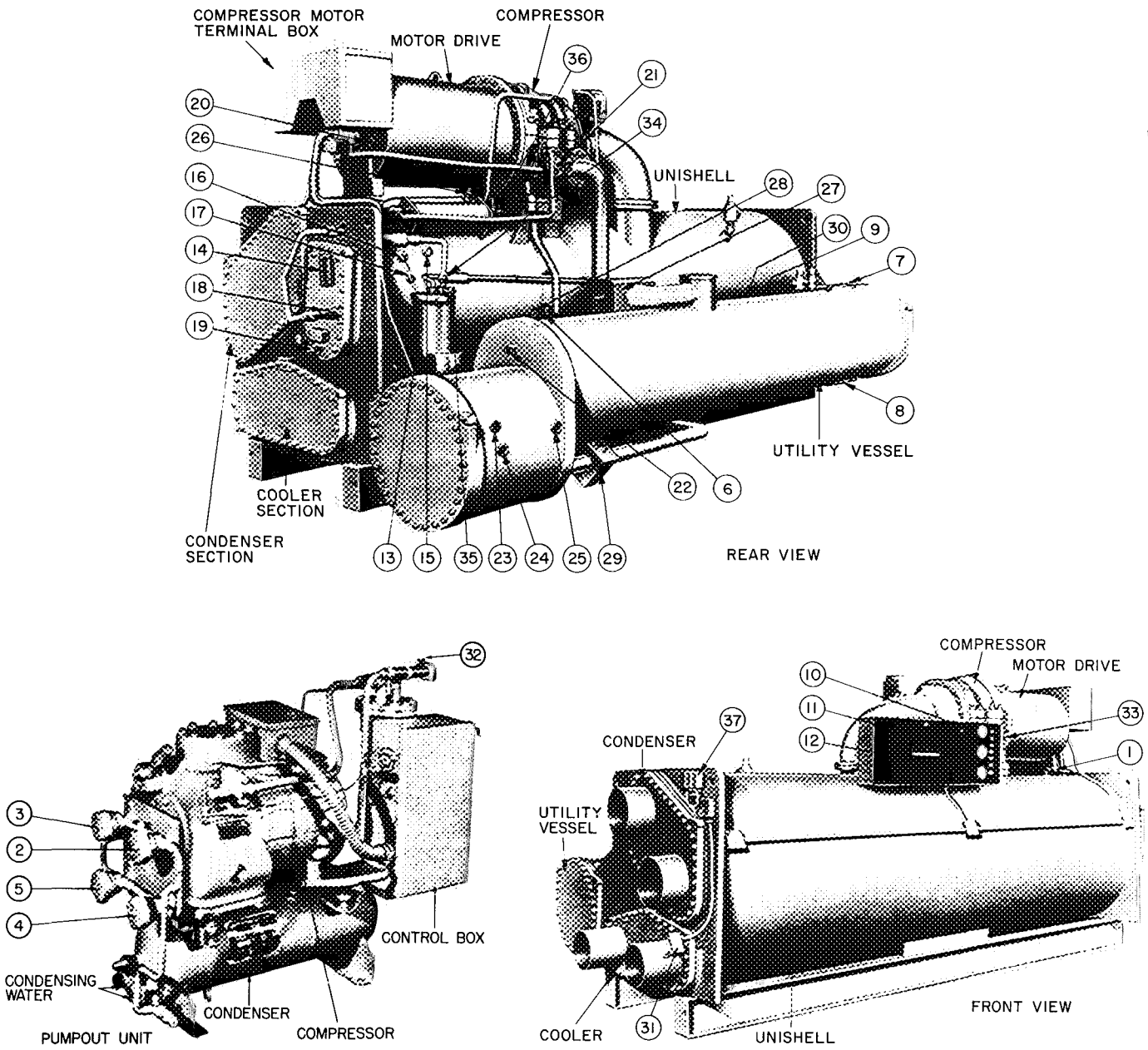

LEGEND

- | | |
|--|---|
| <ul style="list-style-type: none"> 1 Pumpout Service Valve 1 2 Pumpout Service Valve 2 3 Pumpout Service Valve 3 4 Pumpout Service Valve 4 5 Pumpout Service Valve 5 6 Pumpout Service Valve 6 and Refrigerant Charging Valve 7 Pumpout Service Valve 7 8 Pumpout Service Valve 8 9 Service Valve 9 (hidden between unishell and utility vessel) 10 Differential Pressure Gage (oil) 11 Condenser Pressure Gage 12 Cooler Pressure Gage 13 Dehydrator Water Valve 14 Oil Level Sight Glass 15 Oil Temperature Gage 16 Oil Heater (with indicator light) 17 Oil Heater Thermostat 18 Oil Pressure Regulating Valve 19 Oil Reservoir Charging Valve | <ul style="list-style-type: none"> 20. Sight Glass -- Rotation 21. Sight Glass -- Seal Oil 22 Sight Glass -- Liquid Level 23 Sight Glass -- Liquid Level 24. Sight Glass -- Liquid Level 25 Sight Glass -- Liquid Level 26 Refrigerant Drain Valve 27. Isolation Valve 28 Isolation Valve (hidden) 29. Isolation Valve 30. Isolation Valve -- ball valve between unishell and utility vessel (hidden) 31 Chilled Water Control Element 32 Pumpout Vent Valve with Flare Cap 33. Bearing Return Oil Thermometer (hidden) 34 Dehydrator Pressure Gage 35 Dehydrator Discharge Hand Valve 36. Oil Cooler Plug Cock 37 Chilled Water Lo-Temp Cutout |
|--|---|

Fig. 1 – Machine Components

ISOLATION VALVE OPERATION

Opening – *Compressor must be off and vessel pressures equalized* (see Return Refrigerant to Normal Operating Condition, steps 1 thru 6).

1. Loosen packing nut 1/2 to 1 turn so valve stem will rotate and slide smoothly in packing. Do not let refrigerant trapped in valve body escape.
2. *Hold stem in against line pressure* and rotate stem counterclockwise as far as possible.
3. Slide stem out of body.
4. Rotate stem clockwise in the out position, until snug.
5. Tighten packing nut.

Closing

1. Loosen packing nut 1/2 to 1 turn so valve stem will rotate and slide smoothly in packing. Do not let refrigerant trapped in valve body escape.
2. Rotate valve stem counterclockwise as far as possible.
3. Slide stem into valve until it bottoms.
4. Rotate stem clockwise, *holding assembly in*, until it is tight (25 ft-lb).
5. Tighten packing nut.

TRANSFER REFRIGERANT FROM UTILITY VESSEL TO UNISHELL* from normal operating condition.

1. Add manometer near charging valve 6.
2. Close isolation valves (27), (28), and (30).
3. Open valves 1, 3, 4, 6, 7 and 8.
4. Close valves 2, 5 and 9.
5. Ensure that pumpout condenser water is off.
6. Turn on pumpout compressor until liquid is out of utility vessel.
7. Turn off pumpout compressor.
8. Close isolation valve (29).
9. Close valves 3 and 4.
10. Open valves 1, 2, 5 and 6.
11. Turn on pumpout condenser water.
12. Run pumpout compressor until utility vessel pressure reaches 25 in. Hg, ref 30-in. bar. (2.5 psia).
13. Turn off pumpout compressor.
14. Close valves 1, 2, 5 and 6.
15. Turn off pumpout condenser water.

TRANSFER REFRIGERANT FROM UNISHELL TO UTILITY VESSEL* from normal operating condition.

1. Open drain valve (26).
2. Wait one hour; close isolation valves (27), (28) and (30).
3. Open valves 1, 2, 5, 6, 7 and 8.
4. Close valves 3 and 4.
5. Ensure that pumpout condenser water is off.
6. Turn on pumpout compressor for 20 minutes.
7. Turn off pumpout compressor.
8. Close isolation valve (29).
9. Close valves 2 and 5.
10. Open valves 1, 3, 4 and 6.
11. Turn on cooler and condenser pumps and pumpout condenser water.

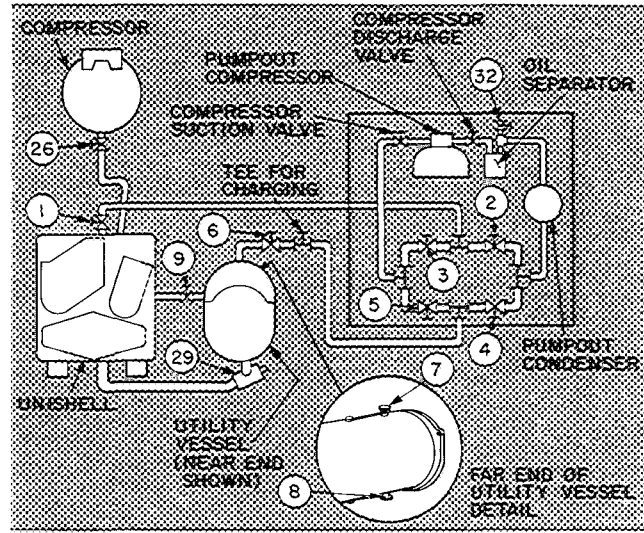

Fig. 2 – Pumpout System Schematic
(See Fig. 1 Legend for Item Ref)

12. Run pumpout compressor until unishell pressure reaches 25 in. Hg, ref 30-in. bar. (2.5 psia). Use dehydrator gage (34) for pressure reading.
13. Turn off pumpout compressor.
14. Close valves 1, 3, 4 and 6.
15. Turn off pumpout condenser water.

UTILITY VESSEL EVACUATING PROCEDURE*

1. Close valves 1, 2, 3, 4 and 9.
2. Open valves 5, 6, 7 and 8.
3. Open vent valve (32) and remove flare cap.
4. Turn off pumpout condenser water.
5. Operate pumpout compressor until manometer reads 25 in. Hg, ref 30-in. bar. (2.5 psia).
6. Close valves 5, 6, 7 and 8.
7. Shut off pumpout compressor.
8. Close vent valve (32) and replace flare cap.

UNISHELL EVACUATING PROCEDURE*

1. Close valves 2, 4, 6 and 9.
2. Open valves 1, 3 and 5.
3. Open vent valve (32) and remove flare cap.
4. Turn off pumpout condenser water.
5. Operate pumpout compressor until manometer reads 25 in. Hg, ref 30-in. bar. (2.5 psia).
6. Close valves 1, 3 and 5.
7. Shut off pumpout compressor.
8. Close vent valve (32) and replace flare cap.

RETURN REFRIGERANT TO NORMAL OPERATING CONDITION *

1. Ensure that opened vessel has been evacuated.
2. Close valves 3, 4 and 5.
3. Open valves 1, 2, 6, 7 and 8.
4. Run water pumps.
- 5a. *If unishell has been evacuated* – Crack open valve 4, gradually increasing pressure in unishell to 35 psig. Feed refrigerant slowly to prevent tube freeze-up.

*See Fig. 1 and 2 for all numbered references.

b. *If utility vessel has been evacuated* – Crack open valve 4 to gradually equalize pressure between unishell and utility vessel. Ensure that unishell pressure does not drop below 35 psig to prevent tube freeze-up.

6. Open valve 4 fully.
7. Open valve (29) to equalize the liquid refrigerant levels between vessels.
8. Close valves 1, 2, 3, 4, 5, 6, 7 and 8.
9. Open isolation valves (27), (28) and (30) and service valve 9.
10. Close drain valve (26).

MACHINE DEHYDRATION – It is recommended that the machine be dehydrated only if it has been open for a considerable period of time, or if there has been a complete loss of unishell holding charge or utility vessel refrigerant charge.

WARNING: Do not start compressor or oil pump even for a rotation check while machine is under dehydration vacuum.

NOTE: Dehydration is readily accomplished at normal room temperature. If room temperature is high, dehydration takes place more quickly. At low room temperatures, dehydration is extremely difficult and special techniques must be applied. Contact your Carrier representative for further information.

Perform dehydration as follows:

1. Connect a dehydration pump to the refrigerant charging valve (6) Fig. 1.
2. Connect a mercury manometer (absolute pressure-type) to the dehydrator discharge hand valve, (35) Fig. 1, and then open the valve. If only the utility vessel is to be dehydrated, a tee for the manometer must be provided between the refrigerant charging valve and a valve on the vacuum or dehydration pump.
3. Open the proper pumpout system valves to evacuate the desired vessel(s).
4. Operate the dehydration pump until the manometer reads 0.20 in. Hg abs (29.80 in. Hg, ref 30-in. bar.); continue to operate pump for 2 more hours.
5. Close refrigerant charging valve; stop dehydration pump; record manometer reading.
6. After a 2-hour wait, take another manometer reading. If reading has not increased, dehydration is complete. If reading has increased, repeat steps 4 and 5.
7. If reading continues to rise after several dehydration attempts, suspect a machine leak. If this is the case, pressurize the unit to approximately 8 to 10 psi with dry air or nitrogen. Locate and repair leak. Then repeat dehydration procedure.

Inspect Piping – Refer to piping diagrams in job data and inspect chilled water, condenser water, and oil cooler water piping. Ensure that flow direction is correct in all cases and that all specified piping requirements are met.

CHECK WATER FLOW RATE – Ensure that cooler and condenser water loop is full, with air vented from high points. Water flow thru cooler

and condenser must meet job requirements. Measure water pressure drop across the cooler and condenser or across the pumps. Check to see that water flow rates agree with design flow.

Oil cooler water supply should meet the following specifications:

Clean water	
Max water temperature	85 F
Max inlet working pressure	100 psi
Water velocity in tube, ft/sec	10 max – 6 min
Water flow, gal./min	7 max – 4 min
Water press. drop, psi diff	5 max – 2 min
Valves and/or controls	Field supplied

Field Wiring – Prior to starting equipment, refer to wiring diagrams in job data and check power supply as follows:

1. Connect a voltmeter across power wires to compressor motor starter and measure voltage. Compare this reading with voltage rating on compressor and starter nameplates.

WARNING: Do not attempt to check high voltage supply without proper equipment. Serious personal injury can result.

2. Compare ampere rating on starter nameplate with ampere rating on motor nameplate.
3. Check voltage to the following components and compare to nameplate values: oil pump starter, pumpout compressor motor starter.
4. Check 120 volt supply to oil heater.
5. Test motor and its power lead insulation resistance using a 500-volt insulation tester such as a megohmmeter. Proceed as follows:
 - a. Open starter main disconnect switch.
 - b. Test the three phases of compressor motor, phase to phase, and phase to ground, with tester connected on the motor side of the starter contactor in the starter. Take resistance readings at 10-second and 60-second intervals for each phase.
 - c. Divide the 60-second resistance reading by the 10-second reading. This gives polarization ratio. The polarization ratio must be 1.15:1 or higher. The 10-second and 60-second resistance readings must be 5.0 megohms or higher.

If the readings are unsatisfactory, repeat the tests at motor terminals with motor power leads disconnected. This will indicate whether fault is in motor or in motor power leads.

Check Starter – Before starting the 19EA, open the main disconnect and then check starter:

1. Remove contactor arc chutes. Be sure contactors move freely, and that shipping string is removed. Replace arc chutes.
2. If starter has been on jobsite for a considerable period, check contactors for dirt and rust. Clean contact magnet surfaces lightly with sandpaper. Apply a very thin coat of vaseline to magnet surfaces, then wipe it off. If starter has been in a dusty atmosphere, vacuum clean starter cabinet and wipe with a lint-free cloth.
3. Remove fluid cups from magnetic overload relays. Add dashpot oil to cups per instructions

on relay nameplate. Oil is shipped in small vials usually attached to starter frame near relays. Use only the dashpot oil shipped with starter. *Do not substitute.* Overload relays are factory set for 108 percent of motor full load amperage. Resetting is not normally required.

4. Check transfer timer for proper time setting. On Star-Delta starters, timers have adjustable ranges of 10 seconds to 3 minutes and are factory set for one minute. On Auto-Transformer starters, timers have adjustable ranges of 0 to 60 seconds and are factory set for 30 seconds.
5. With main disconnect switch open, manually open and close main control relay (1CR) to be sure it operates freely.

Oil Charge is shipped in the oil reservoir. Check sight glass (14) to be certain oil is visible. If oil must be added, it must meet Carrier's oil specification. Charge oil thru the oil reservoir charging valve (19). Use a hand pump to charge the oil against machine pressure.

Oil Heater — Energize the oil heater to minimize absorption of refrigerant by the oil. A light (16) indicates when the heater is energized. Set the oil heater thermostat to maintain a minimum temperature of 145 F at shutdown.

Refrigerant Charge is shipped in the utility vessel. If refrigerant must be added, charge it thru the refrigerant charging valve (6).

WARNING: Never charge liquid refrigerant into the unishell if the pressure is below 35 psig. Below 35 psig, R-12 will flash to a gas at a temperature below the freezing point of water. With cooler and condenser water flowing, charge the refrigerant as a gas until the vessel pressure is above 35 psig.

Refer to Trimming Refrigerant Charge for full load adjustment.

Check Operation of Safety Controls — As the following checks are made, the panel lights should appear as shown in the diagrams.

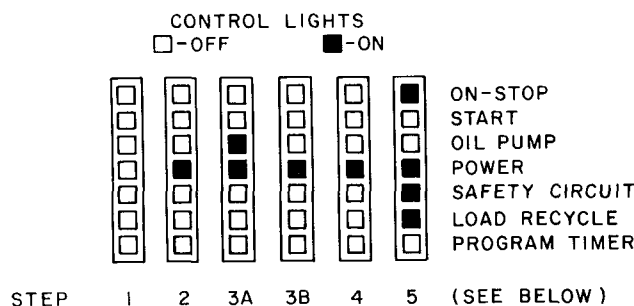

1. Disconnect main motor leads in starter.
2. Energize the control circuit.
- 3a. With water pumps off, press oil pump button for several seconds to determine oil pressure on differential gage. With pump running, confirm that circuit between terminals ①⑦ and ④⑦ is closed by using an ohmmeter.

- b. Release the oil pump button. Circuit between terminals ①⑦ and ④⑦ must open.
4. Start the chilled water and condenser water pumps. Confirm that circuit between terminals ④⑦ and ①④ is closed with pumps running, and opens when pumps stop and flow switches open.
5. Press ON-STOP button. If safety circuit light is off, check resets on the condenser high-pressure safety, cooler low-pressure safety, bearing and motor high-temperature circuit breakers and compressor motor overloads in starter. Check 3-amp fuse in control center. If safety circuit light is on but load recycle light is off, check the automatic resetting chilled water recycle switch. If both lights are on, manually trip and then reset bearing and motor high-temperature circuit breakers and compressor motor overloads to be sure they cut off the safety light. Tripping the chilled water recycle switch will cut off the load recycle light only.

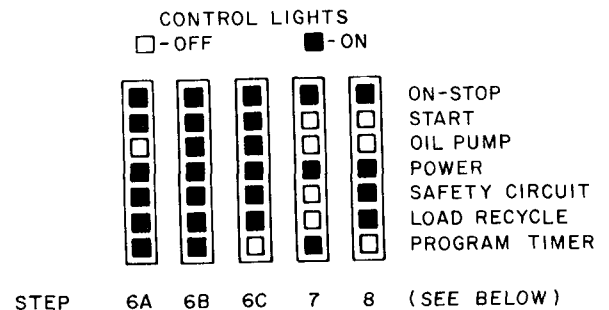

- 6a. Press machine START button. (Motor leads disconnected and water pumps running.)
- b. Oil pump starts within 30 seconds.
- c. Compressor motor start contacts will close 30 seconds later. Starter will transfer to its run condition 30 to 60 seconds after starter is energized.
7. Open the oil pump main disconnect. Starter must de-energize. Close disconnect.
8. In approximately 15 minutes, the program timer will complete the antirecycle portion of its cycle and the machine may be started.
9. Open circuit breaker and reconnect main motor leads.

START-UP

Preliminary Checks

1. Power on to main circuit breaker, control circuit, water pumps and tower fan.
2. Cooling tower water level.
3. Oil reservoir level and refrigerant level.
4. Oil reservoir temperature 145 F or warmer.
5. All isolation valves open. See (27), (28), (29) and (30) of Fig. 1. If valves are closed, follow isolation valve procedure on page 3.
6. Oil cooler plug cock, (36) Fig. 1, cracked open, and any other valves in oil cooler line fully open.

7. Valves in chilled water and condenser water circuits open and water circulating properly. Do not permit water warmer than 100 F to flow thru cooler.

COMPRESSOR ROTATION – Set capacity control (item 2, Fig. 3) to “Hold.” Press machine ON-STOP and START buttons.

As soon as motor starts to turn, press machine ON-STOP button. Check motor rotation thru sight glass in motor end bell (Fig. 1). Motor rotation must be clockwise when viewed from motor end. If

not, reverse any 2 of 3 power leads coming into motor starter and recheck rotation.

COMPRESSOR OPERATION

Press machine ON-STOP and START buttons and let compressor come up to speed. Press machine ON-STOP button and listen for any unusual sounds coming from the compressor and transmission housing as compressor coasts to a stop.

add

Program timer prevents rapid recycling of compressor and allows restart 15 minutes after stop.

Checking Safety Control Settings

While performing these checks, carefully monitor chilled water temperature to prevent freeze-up. Protection by safety controls cannot be assumed until settings have been confirmed as follows.

Open main disconnect (all power off to starter and controls). Set capacity control to “Hold.” Place a clamp-on ammeter on one of the 3 starter leads. Install jumper between ⑩ and ⑪. Close disconnect(s), start compressor and check oil pressure and temperature (items 10 and 15, Fig. 1). With compressor running, manually operate the prewhirl vanes with the capacity control switch. Do not exceed 100 percent full load amperage.

1. Set control 1 (chilled water low temperature cutout) as indicated in Table 3.
2. Stop machine, open disconnect(s), remove jumper and check controls 2 and 3 of Table 3.
3. Controls 4 and 5 do not require alteration of factory settings.
4. Control 6 may require adjustment for operation of unit at low design suction. Refer to Table 3.

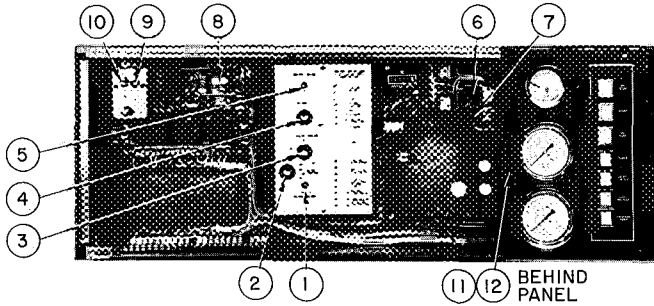

LEGEND

1. Motor Current Calibration Adjustment
2. Capacity Control Switch
3. Electrical Demand Adjustment
4. Thermostat (chilled water)
5. Throttle Range Adjustment
6. Condenser High-Pressure Cutout Switch (manual reset)
7. Cooler Low-Pressure Cutout Switch (manual reset)
8. Program Timer
9. Motor High-Temperature Cutout (manual reset)
10. Bearing High-Temperature Cutout (manual reset)
11. Low Oil Pressure Cutout
12. Economizer-Cooler Differential Pressure Switch

Fig. 3 – Control Center

Table 3 – Checking Safety Controls

SAFETY OR CONTROL DEVICE	RECOMMENDED SETTING
<p>1. Chilled Water Low-Temperature Cutout and Recycle Switch (Fig. 1)</p> <p>TEMPERATURE ADJUSTMENT</p> <p>DIFFERENTIAL ADJUSTMENT</p>	<ol style="list-style-type: none"> 1. Set this switch to break at approximately 5 F below design chilled water temperature, or at 36 F, whichever is higher 2. Set the differential at 10 F ± 1 F so that when the machine shuts down automatically at approximately 5 F below the design chilled water temperature it will restart at approximately 5 F above the design water temperature. 3. This control must break ahead of the cooler low-pressure cutout or the machine will not recycle automatically
Perform checks 2 and 3 with machine stopped and jumper removed	
<p>2. Oil Heater Thermostat (Fig. 1)</p> <p>LOCKING SCREW</p> <p>ADJUSTING SCREW</p>	<p>Set the oil heater thermostat to maintain a minimum oil reservoir temperature of 145 F at shutdown</p>

Table 3 – Checking Safety Controls (cont)

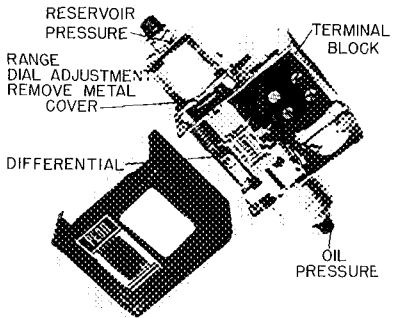
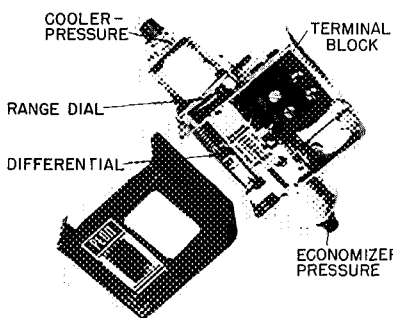
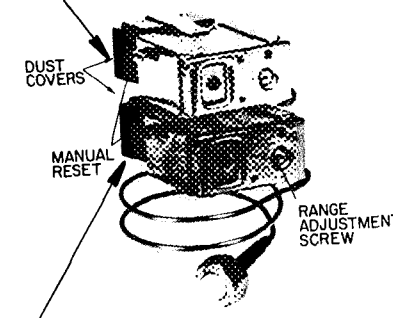
SAFETY OR CONTROL DEVICE	RECOMMENDED SETTING
<p>3. Low Oil Pressure Cutout (Fig. 3)</p> 	<p>Factory set to cut out at 13 ± 1 psi differential. Operate oil pump manually. Remove cap and gasket from regulating valve (item 18, Fig. 1). Loosen locknut. Turn adjusting screw counterclockwise to lower oil pressure to 12 psi differential. If safety does not trip, turn range dial clockwise until cutout occurs. Access to control is thru knockout at rear of control box.</p>
<p>4. Economizer Cooler Differential Pressure Switch (Fig. 3)</p> 	<p>The economizer-cooler differential pressure switch is factory set to energize the refrigerant feed control at 10 psid.</p>
<p>5. Condenser High-Pressure Cutout (Fig. 3)</p>  <p>6. Cooler Low-Pressure Cutout (Fig. 3)</p>	<p>The condenser high pressure switch is factory set to shut machine down when condenser pressure reaches 161 ± 5 psig. Field calibration is not required.</p> <p>Cooler low-pressure switch is factory set at 32 ± 2 psig. If design suction temperature is below 36 F, field resetting may be necessary. With control power off (power light out), install jumpers between terminals 10 and 11 and between 40 and 43. Set switch to cut out at one degree below design suction temperature. Remove jumpers. Restore power.</p>

Setting Operating Controls

MOTOR CURRENT CALIBRATION PROCEDURE

1. Establish a steady motor current value for this calibration. Open guide vanes manually (capacity control to "Inc") until full load current is reached. Motor current calibration adjustment (item 1, Fig. 3) may have to be turned counterclockwise to permit vanes to open further. *Do not exceed 105 percent of nameplate full load amps*

If building load is sufficient to maintain full load current for a period of time, calibrate at this condition. With small loads, pull down to and maintain (capacity control to "Hold")

design leaving chilled water temperature and calibrate at this condition.

2. Measure motor current at selected condition. Determine its percentage of full load motor current.
3. Use this percentage figure to set the electrical demand adjustment (item 3, Fig. 3) per the following table:

Percent of Full Load Motor Current	Electrical Demand Adjustment Setting
105	100 percent
85 or above	80 percent
65 to 84	60 percent
45 to 64	40 percent
below 45	Control cannot be calibrated

4. Turn the motor current calibration adjustment fully clockwise. This will force the guide vanes to close part way.
5. Turn the thermostat adjustment (item 4, Fig. 3) to "Cooler" (fully counterclockwise).
6. Set the capacity control switch (item 2, Fig. 3) to "Inc" position.
7. Slowly turn the motor current calibration adjustment counterclockwise, allowing the guide vanes to open until the motor current reaches 5 percentage points above the electrical demand setting.

NOTE: There is a time lag of several seconds due to feedback capacitance in the motor current circuit. When motor current calibration setting is adjusted, this time lag should be allowed for.

8. Check the foregoing motor current calibrations with machine under "Auto" control as follows:
 - a. Close vanes manually (capacity control to "Dec").
 - b. Turn capacity control to "Auto." Vanes should stop opening at electrical demand setting.
9. If control was calibrated at less than 100 percent load, turn electrical demand adjustment setting to 100 percent. Control is now automatically calibrated for 100 percent full load motor current.

This is a two-step motor current limiting circuit. At 100 percent full load motor current, the vanes will stop opening any further. If the motor current should increase to 105 percent due to some change in load conditions, the vanes will close until the motor current is reduced to about 102 percent. If the motor current is reduced to 98 percent or below, the control will respond to leaving chilled water temperature. The electrical demand adjustment allows the operator to reduce the maximum current drawn by the motor, minimizing the electrical demand rate during the off season operation.

NOTE: If control cannot be calibrated with above procedure, check voltage signal from signal resistor in starter. At 100 percent full load current, voltage between terminals 23 and 24 inside control panel must be 0.5 ± 0.1 volts. If not in this range, check sizing of resistor in starter.

CHILLED WATER CALIBRATION PROCEDURE

1. Turn throttle range calibration adjustment (item 5, Fig. 3) fully clockwise.
2. Turn chilled water thermostat (item 4, Fig. 3) until design chilled water temperature is maintained. Mark thermostat at this position. If capacity control vanes hunt, turn throttle range calibration adjustment counterclockwise in small increments until hunting ceases. Chilled water thermostat may require resetting.

Trimming Refrigerant Charge — After the machine has been placed in operation, it may be necessary to adjust the refrigerant charge to obtain optimum machine performance.

When machine full load is available, add or remove refrigerant slowly until the difference between leaving chilled water temperature and the cooler temperature reaches design conditions or becomes a minimum. Shut the machine down and allow refrigerant level to equalize between vessels. Mark the level indicator (items 23, 24 or 25, Fig. 1) and maintain that shutdown refrigerant level.

INSTRUCTING THE CUSTOMER OPERATOR

Be sure the operator carefully reads the 19EA Operating and Maintenance Instructions.

Point out the following components; explain their function and the system in which they are used.

Compressor

Guide vanes, vane motor and linkage
Refrigerant-cooled motor
Transmission

Unishell

Cooler, condenser
Relief valve, isolation valves

Utility Vessel

Float chambers, sight glasses
Relief valves, charging valve

Dehydrator

Importance of proper operation
Valves and system operation
Sight glasses, gage

Lubrication System

Oil pump, cooler, filter
Solenoid, plug-cock
Heater, thermostat, temperature gage
Oil level and temperature

Pumpout System

Compressor, condenser, oil separator
Valve designation and cycle

Control System

Manual switches, gages and lights
Operating controls, safety controls
Auxiliary and special controls

Auxiliaries

Starter(s), pumps, cooling tower

Describe Refrigeration Cycle

Review Maintenance

Scheduled, extended shutdown
Importance of Log Sheet Record
Importance of water treatment

Check Operator Knowledge

Start-stop procedure
Safety and Operating Controls

Carrier Service

Advise operator of availability, and method of ordering parts.

Review Operating and Maintenance Instructions.

Manufacturer reserves the right to change any product specifications without notice.

CARRIER AIR CONDITIONING COMPANY • SYRACUSE, NEW YORK